

## Brivio

SMALL TABLE DESIGN BY VF DESIGN STUDIO

Il tavolino Brivio fa della sua doppia natura il suo punto di forza: può essere concepito come sontuoso elemento indipendente, oppure esaltarsi in abbinamento alla famiglia di divano modulare da cui prende il nome. Brivio è un tavolino contemporaneo ed elegante, dall'impatto visivo leggero, ma che porta con sé la concretezza e le texture naturalmente uniche del marmo.

*Brivio makes its dual nature its strength: it can be conceived as a sumptuous free-standing element, or it can be enhanced in combination with the modular sofa family it takes its name from. Brivio is a contemporary and elegant side table, with a light visual impact, but which brings with it the concreteness and the naturally unique textures of marble.*

**Struttura:** metallo ricoperto in pelle a scelta.

**Basamento:** legno rivestito in pelle a scelta.

**Ripiano inferiore:** vetro retro-laccato nero opaco.

**Piano:** marmo, disponibile tra quelli in collezione.

**Structure:** metal covered in leather at choice.

**Base:** wood covered in leather at choice.

**Bottom shelf:** black back-lacquered glass.

**Top:** marble top, available among the ones from VF collection.



**BRIVIO**  
SMALL TABLE DESIGN BY VF DESIGN STUDIO

**TAVOLINI / SMALL TABLES**

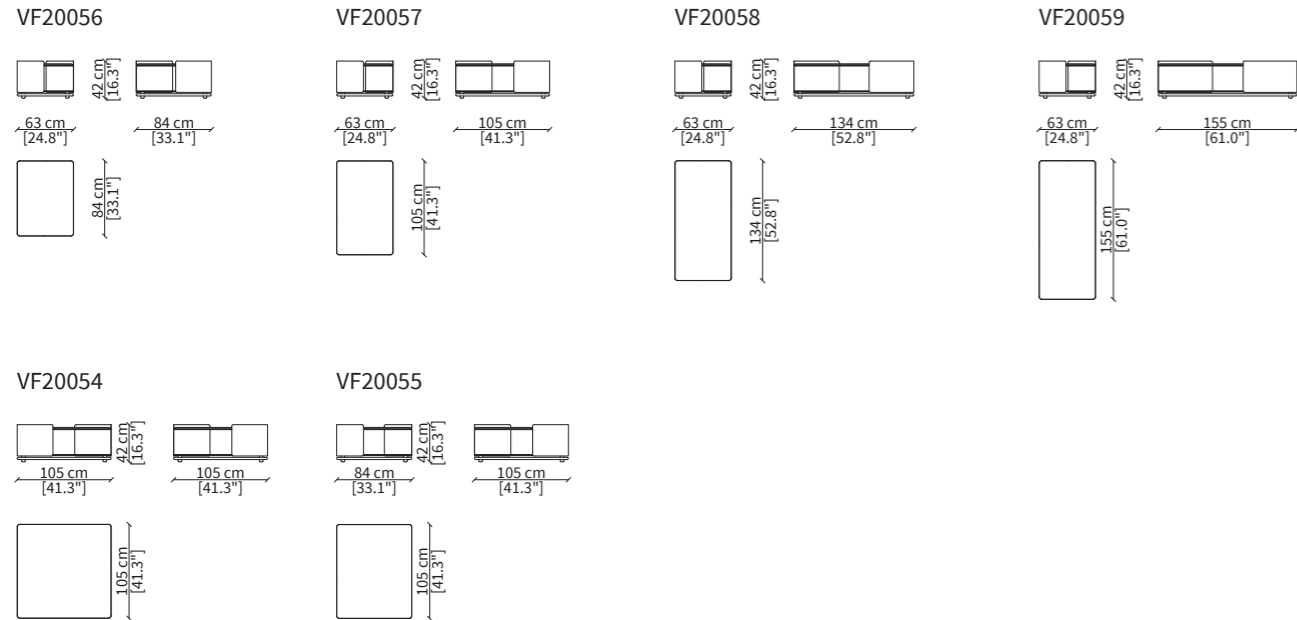

Dimensioni espresse in cm se non diversamente indicato.  
L'Azienda si riserva il diritto di apportare modifiche ai modelli senza preavviso.  
Tolleranza sulle misure indicate di +/- 2%.

Dimensions in centimeter if not differently indicated.  
The Company reserves the right to change the models without any advance notice.  
Tolerance on the given sizes +/- 2%.

**BRIVIO**  
SOFA DESIGN BY VF DESIGN STUDIO

**B BRACCIOLLO BASSO / LOW ARMREST / h. 59 cm**

**A BRACCIOLLO ALTO / HIGH ARMREST / h. 71 cm**



**DIVANI / SOFAS**

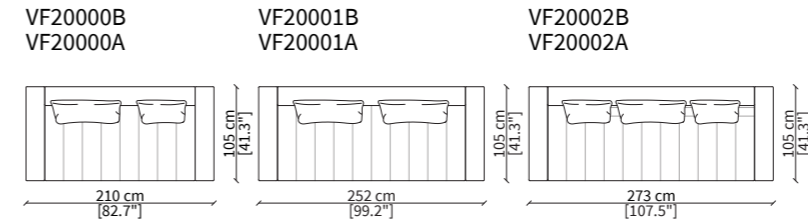

**ELEMENTI TERMINALI / TERMINAL ELEMENTS**

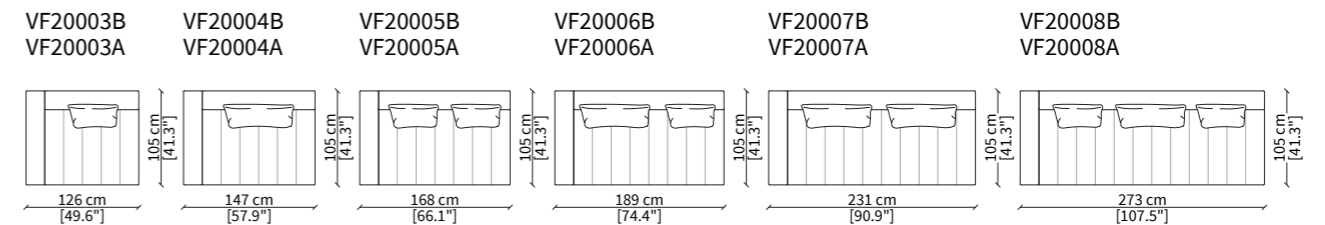

**ELEMENTI CENTRALI / CENTRAL ELEMENTS**

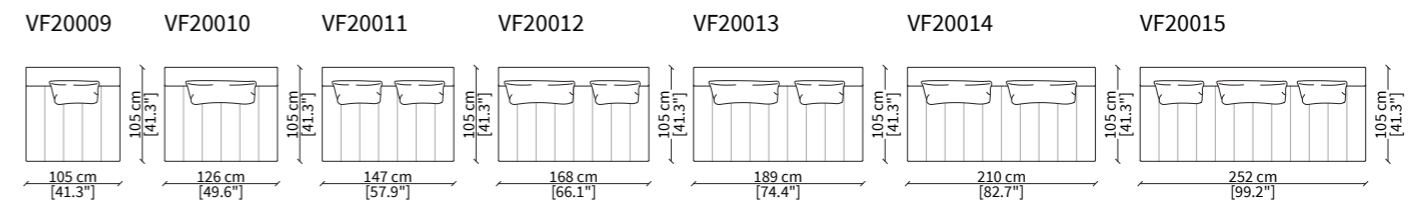

**ELEMENTI DORMEUSE / DORMEUSE ELEMENTS**

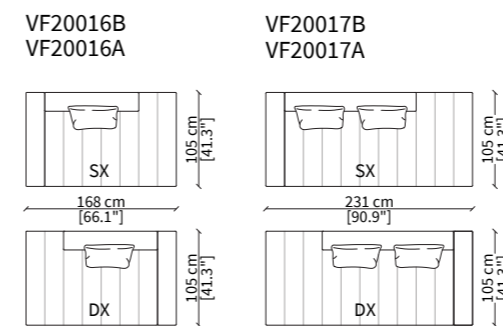

Dimensioni espresse in cm se non diversamente indicato.  
L'Azienda si riserva il diritto di apportare modifiche ai modelli senza preavviso.  
Tolleranza sulle misure indicate di +/- 2%.

Dimensions in centimeter if not differently indicated.  
The Company reserves the right to change the models without any advance notice.  
Tolerance on the given sizes +/- 2%.

**ELEMENTI CENTRALI DORMEUSE / CENTRAL DORMEUSE ELEMENTS**

VF20018 VF20019

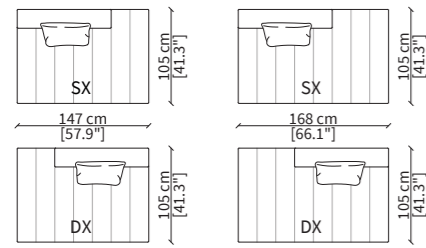

**CHAISES LONGUE**

VF20023B  
VF20023A

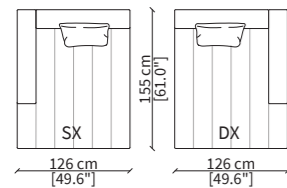

**ELEMENTI TERMINALI COMFORT / COMFORT TERMINAL ELEMENTS**

VF20060B  
VF20060A

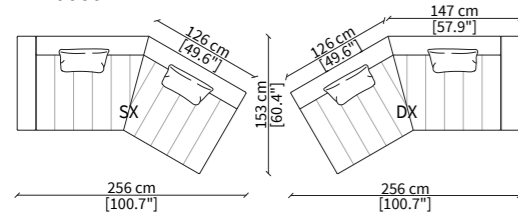

**ELEMENTI DORMEUSE COMFORT / COMFORT DORMEUSE ELEMENTS**

VF20021

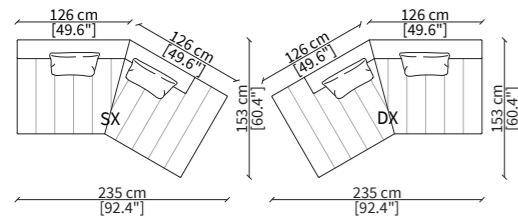

**CHAISE LONGUE CENTRALE / CENTRAL CHAISE LONGUE**

VF20022

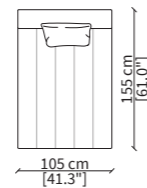

**ELEMENTO CENTRALE COMFORT / COMFORT CENTRAL ELEMENT**

VF20020

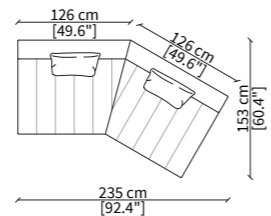

**ELEMENTO ANGOLO / CORNER ELEMENT**

VF20024

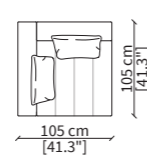

Dimensioni espresse in cm se non diversamente indicato.  
L'Azienda si riserva il diritto di apportare modifiche ai modelli senza preavviso.  
Tolleranza sulle misure indicate di +/- 2%.

Dimensioni in centimeter if not differently indicated.  
The Company reserves the right to change the models without any advance notice.  
Tolerance on the given sizes +/- 2%.

**ELEMENTI SEDUTA PER BRIVIO DOUBLE / SEAT ELEMENTS FOR BRIVIO DOUBLE**

**B BRACCIOLLO BASSO / LOW ARMREST / h. 59 cm**

**A BRACCIOLLO ALTO / HIGH ARMREST / h. 71 cm**



**ELEMENTI SEDUTA TERMINALE / TERMINAL SEAT ELEMENTS**

VF20025B VF20026B VF20027B VF20028B VF20029B  
VF20025A VF20026A VF20027A VF20028A VF20029A

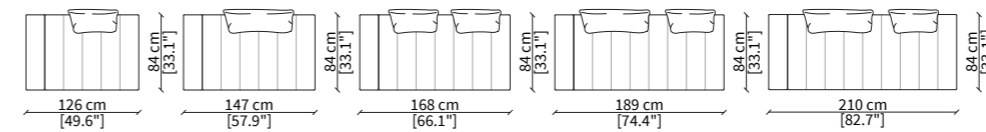

**ELEMENTI SEDUTA CENTRALI / CENTRAL SEAT ELEMENTS**

VF20030 VF20031 VF20032 VF20033 VF20034 VF20035

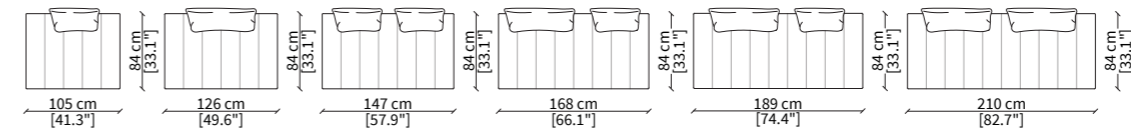

**ELEMENTI SEDUTA CHAISE LONGUE / CHAISE LONGUE SEAT ELEMENTS**

VF20037B  
VF20037A

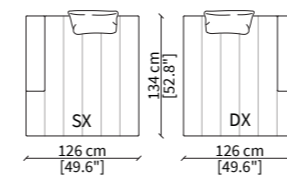

**ELEMENTI SEDUTA CENTRALI CHAISE LONGUE / CENTRAL CHAISE LONGUE SEAT ELEMENTS**

VF20036

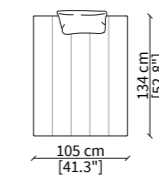

Dimensioni espresse in cm se non diversamente indicato.  
L'Azienda si riserva il diritto di apportare modifiche ai modelli senza preavviso.  
Tolleranza sulle misure indicate di +/- 2%.

Dimensioni in centimeter if not differently indicated.  
The Company reserves the right to change the models without any advance notice.  
Tolerance on the given sizes +/- 2%.

**POUFS**

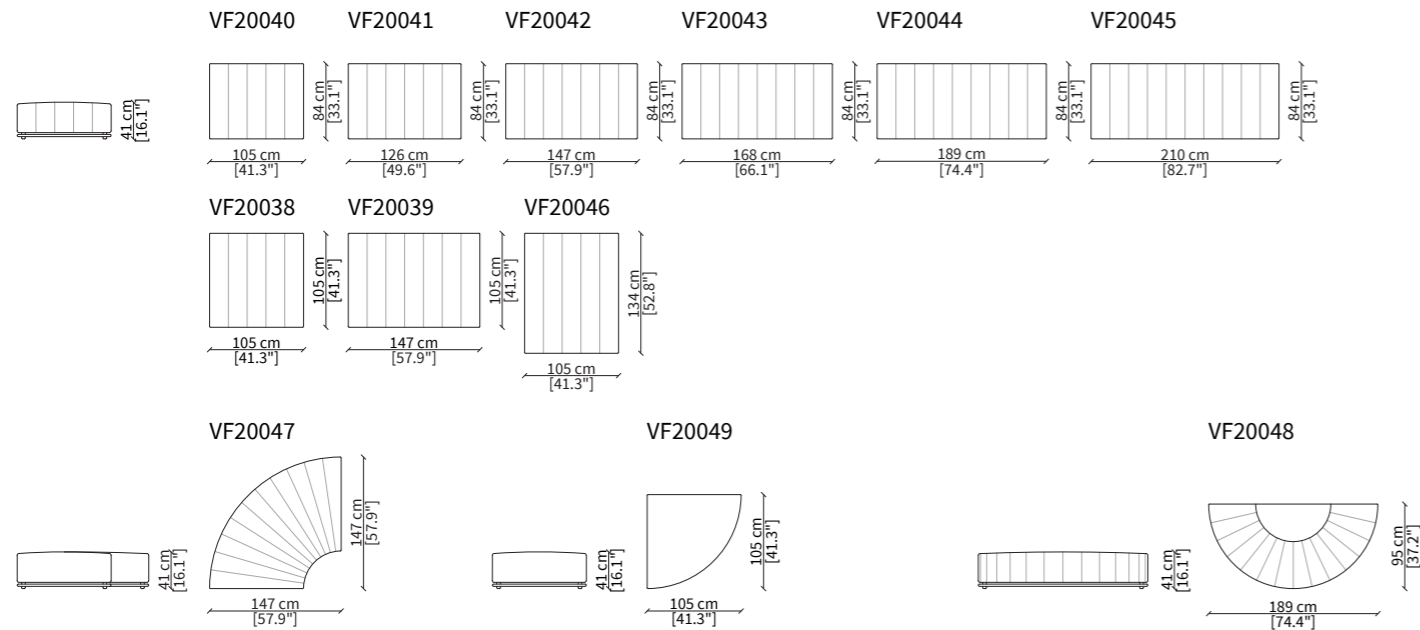

**VOLUMI / VOLUMES**

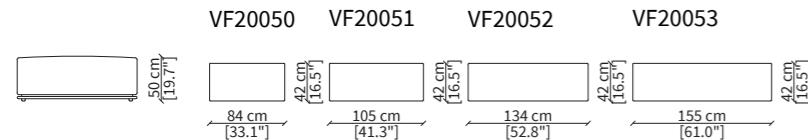

**TAVOLINI / SMALL TABLES**

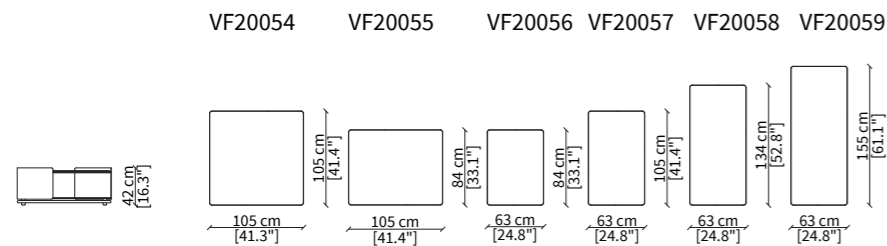

**CUSCINI / CUSHIONS**

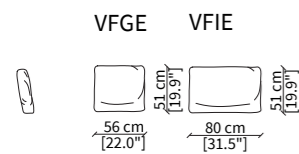

Dimensioni espresse in cm se non diversamente indicato.  
L'Azienda si riserva il diritto di apportare modifiche ai modelli senza preavviso.  
Tolleranza sulle misure indicate di +/- 2%.

Dimensions in centimeter if not differently indicated.  
The Company reserves the right to change the models without any advance notice.  
Tolerance on the given sizes +/- 2%.

**ESEMPI DI COMPOSIZIONE AD ANGOLO CON BRACCIOLO BASSO /**  
EXAMPLES OF CORNER COMPOSITIONS WITH LOW ARMREST

Le composizioni ad angolo possono essere così realizzate:  
Corner composition can be built as follows:

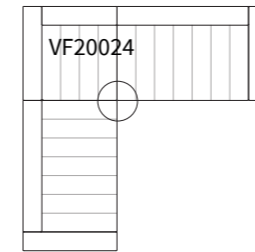

1. utilizzando l'angolo (art. **VF20024**) per un allineamento preciso delle sedute.

1. by using the corner (art. **VF20024**) for a perfect alignment of the seats.

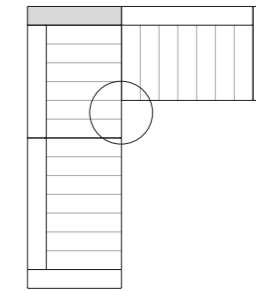

2. utilizzando un terminale con bracciolo alto per creare un angolo. Sugeriamo l'aggiunta di un cuscino schienale per maggior comfort.

2. by using a terminal with high armrest to create a corner. We recommend adding an extra back cushion for a better comfort.

**ESEMPI DI COMPOSIZIONE AD ANGOLO CON BRACCIOLO ALTO /**  
EXAMPLES OF CORNER COMPOSITIONS WITH HIGH ARMREST

Le composizioni ad angolo possono essere così realizzate:  
Corner composition can be built as follows:

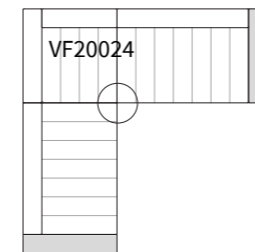

1. utilizzando l'angolo (art. **VF20024**) per un allineamento preciso delle sedute.

1. by using the corner (art. **VF20024**) for a perfect alignment of the seats.

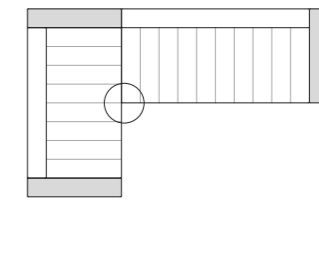

2. accostando tra loro gli elementi con bracciolo alto. Sugeriamo l'aggiunta di un cuscino schienale per maggior comfort.

2. by combining the elements with high armrest. We recommend adding an extra back cushion for a better comfort.

Dimensioni espresse in cm se non diversamente indicato.  
L'Azienda si riserva il diritto di apportare modifiche ai modelli senza preavviso.  
Tolleranza sulle misure indicate di +/- 2%.

Dimensions in centimeter if not differently indicated.  
The Company reserves the right to change the models without any advance notice.  
Tolerance on the given sizes +/- 2%.

**BRIVIO**  
SOFA DESIGN BY VF DESIGN STUDIO

COMPOSIZIONE 1 / COMPOSITION 1

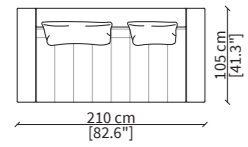

CODICI / CODES: **VF20000B**

COMPOSIZIONE 2 / COMPOSITION 2

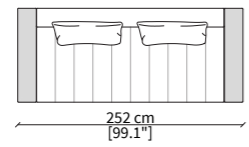

CODICI / CODES: **VF20001A**

COMPOSIZIONE 3 / COMPOSITION 3

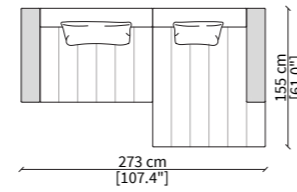

CODICI / CODES: **VF20004A, VF20023A**

**BRIVIO**  
SOFA DESIGN BY VF DESIGN STUDIO

COMPOSIZIONE 10 / COMPOSITION 10

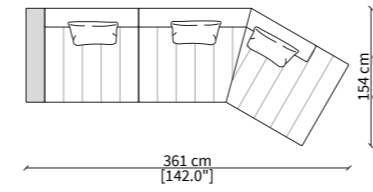

CODICI / CODES: **VF20003A, VF20021**

COMPOSIZIONE 11 / COMPOSITION 11

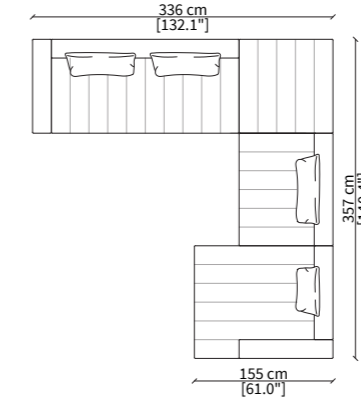

CODICI / CODES: **VF20007B, VF20038, VF20010, VF20023B**

COMPOSIZIONE 12 / COMPOSITION 12

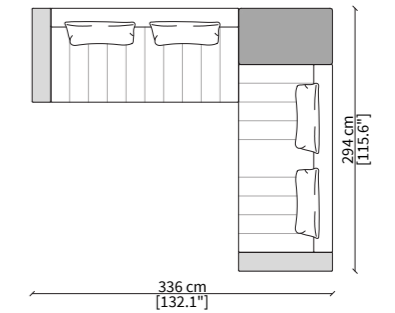

CODICI / CODES: **VF20007A x 2, VF20057**

COMPOSIZIONE 4 / COMPOSITION 4

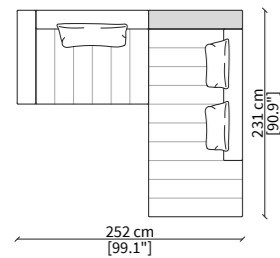

CODICI / CODES: **VF20004B, VF20017A**

COMPOSIZIONE 5 / COMPOSITION 5

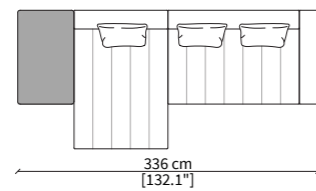

CODICI / CODES: **VF20057, VF20022, VF20005B**

COMPOSIZIONE 6 / COMPOSITION 6

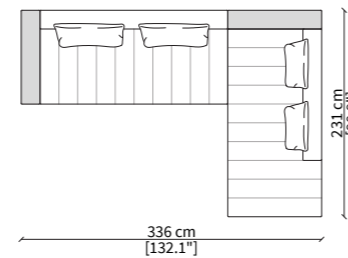

CODICI / CODES: **VF20007A, VF20017A**

COMPOSIZIONE 13 / COMPOSITION 13

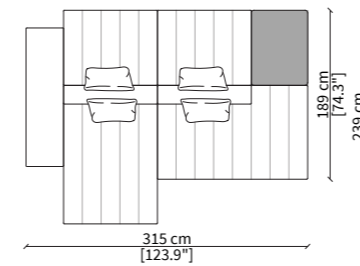

CODICI / CODES: **VF20053, VF20030 x 2, VF20056, VF20022, VF20019**

COMPOSIZIONE 14 / COMPOSITION 14

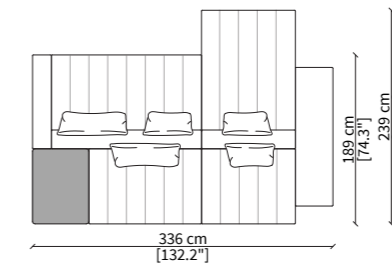

CODICI / CODES: **VF20006B, VF20022, VF20053, VF20056, VF20031, VF20030**

COMPOSIZIONE 15 / COMPOSITION 15

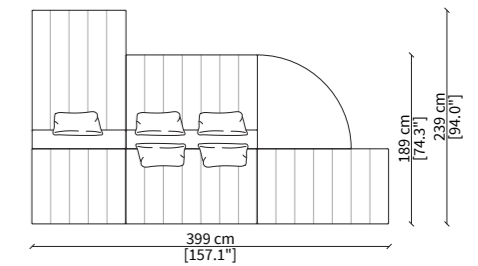

CODICI / CODES: **VF20022, VF20011, VF20049, VF20040, VF20032, VF20042W**

COMPOSIZIONE 7 / COMPOSITION 7

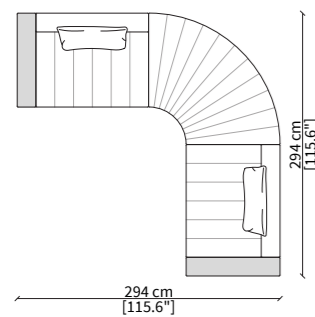

CODICI / CODES: **VF20004A x 2, VF20047**

COMPOSIZIONE 8 / COMPOSITION 8

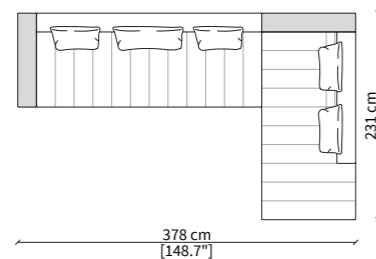

CODICI / CODES: **VF20008A, VF20017A**

COMPOSIZIONE 9 / COMPOSITION 9

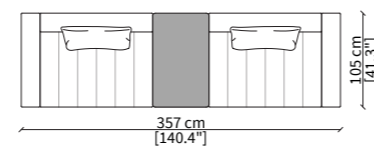

CODICI / CODES: **VF20004B x 2, VF20057**

COMPOSIZIONE 16 / COMPOSITION 16

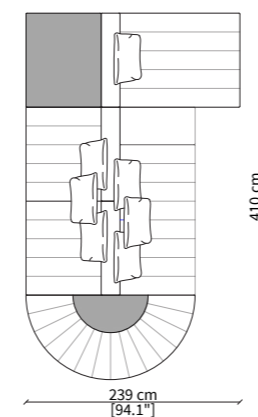

CODICI / CODES: **VF20055, VF20030 x 2, VF20048, VF20022, VF20050 VF20033**

COMPOSIZIONE 17 / COMPOSITION 17

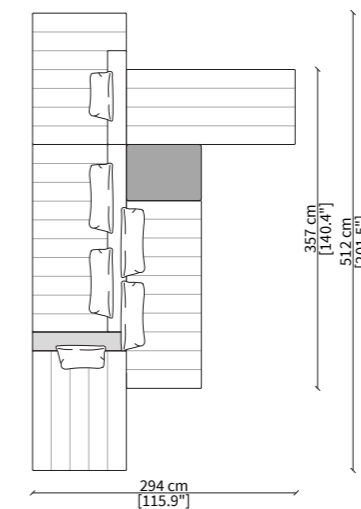

CODICI / CODES: **VF20018, VF20007A, VF20036, VF20044, VF20056, VF20035**

COMPOSIZIONE 18 / COMPOSITION 18

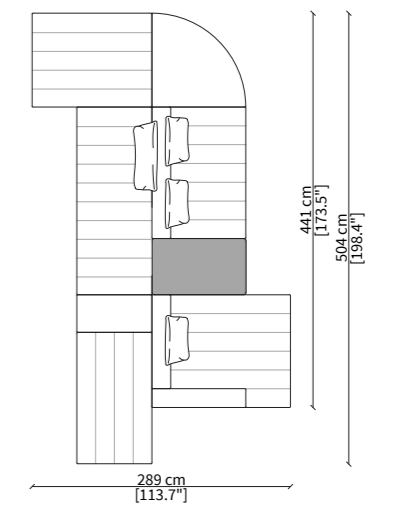

CODICI / CODES: **VF20046, VF20035, VF20050, VF20042, VF 20049, VF20011, VF20057, VF20023B**

Dimensioni espresse in cm se non diversamente indicato.  
L'Azienda si riserva il diritto di apportare modifiche ai modelli senza preavviso.  
Tolleranza sulle misure indicate di +/- 2%.

Dimensions in centimeter if not differently indicated.  
The Company reserves the right to change the models without any advance notice.  
Tolerance on the given sizes +/- 2%.

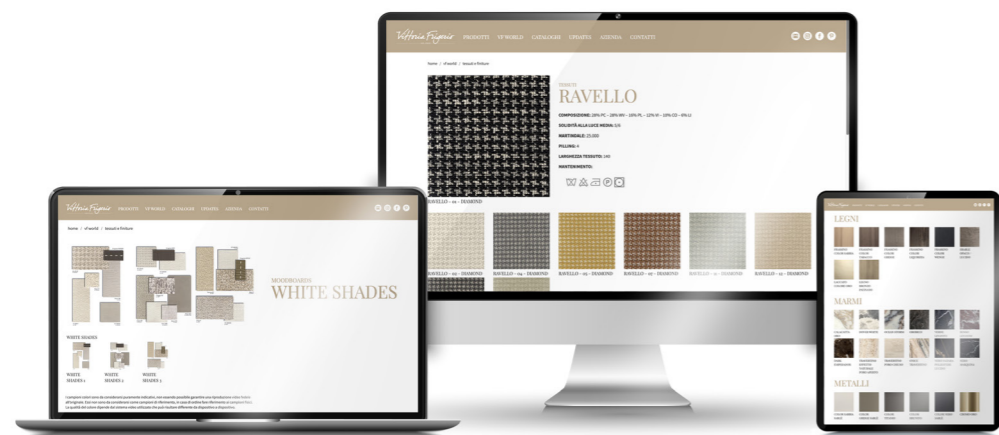

Via Sant'Agata 63  
22066 Mariano Comense (CO) - Italy  
Tel. +39 031 5481225  
info@vittoriafrigerio.it  
www.vittoriafrigerio.it

Per la gamma completa di materiali è possibile consultare il nostro sito web [www.vittoriafrigerio.it](http://www.vittoriafrigerio.it)  
The full range of materials can be found on our website at [www.vittoriafrigerio.it](http://www.vittoriafrigerio.it)



[WWW.VITTORIAFRIGERIO.IT](http://WWW.VITTORIAFRIGERIO.IT)